

TRADI Bois



Haute performance thermique

- Uc jusqu'à 0,53

Le volet roulant avec un encombrement optimisé pour la maison à ossature bois

- La réservation la plus petite

Esthétique

- Laisse place nette aux murs et aux rideaux

100% réglé en usine

- Tablier déjà monté sur l'axe en usine, montage rapide

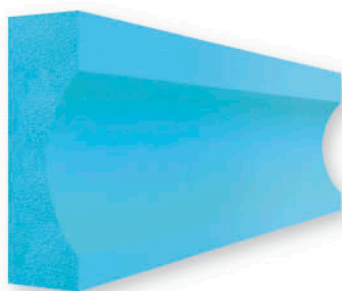

En option, coque polystyrène pour de hautes performances thermiques :

- Uc = 0,53 (hauteur < 1450 mm)
- Uc = 0,72 (hauteur > 1450 mm)

montage rapide

enroulement Intérieur

enroulement Extérieur

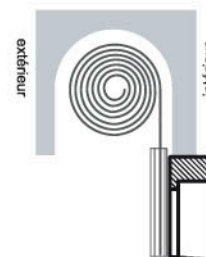
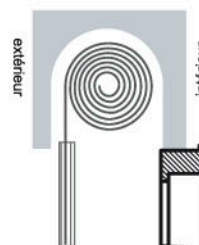

> Caractéristiques techniques

▶ Lames

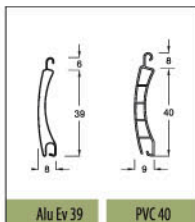

TYPE	Pas de lame	Poids /m ²	Surface maxi Tablier	Largeur maxi Tablier
Alu Ev 39	39	2,50	6,00	2800
PVC Ev 40	40	3,07	4,32	1800

▶ Coulisses

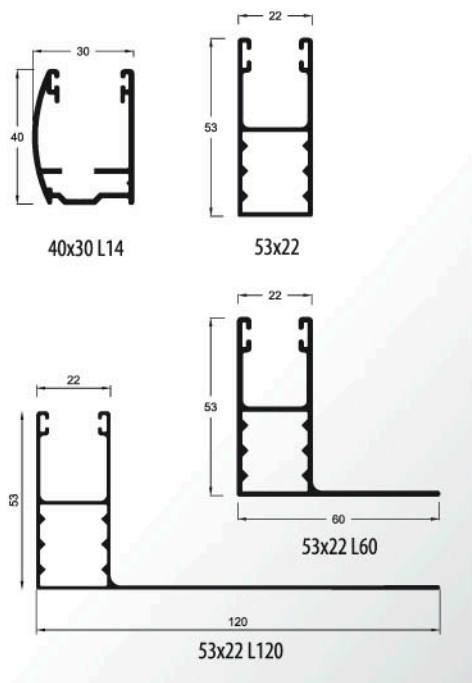

▶ Encombrement

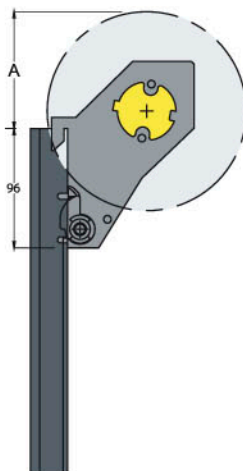

Coque PS	Type Lame	Hauteur Maxi	Ø Enroulement	A
Standard	Alu Ev 39	2250	160	94
	PVC 40	1650		
Renforcé	Alu Ev 39	1450	135	80
	PVC 40	1130		

▶ Limites d'utilisation des lames

H/L	500	600	700	800	900	1000	1100	1200	1300	1400	1500	1600	1700	1800	1900	2000	2100	2200	2300	2400	2500	2600	2700	2800	
650																									
750																									
850																									
950																									
1050																									
1150																									
1250																									
1350																									
1450																									
1550																									
1650																									
1750																									
1850																									
1950																									
2050																									
2150																									
2200																									
2250																									

▶ Sortie de manœuvre

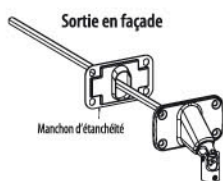

▶ Limites Manœuvre Tringle Oscillante

Type de tablier	Tringle Oscillante		
	Hauteur maxi	Largeur maxi	Surface maxi
Alu Ev 39	Non réalisable	2800	6,00
PVC 40	Non réalisable	1800	4,25

▶ Manœuvres

	Tradi Bois
Zuni R	X
Radio IO et RTS	X
Filaire SIMU	X
Filaire SOMFY	X
TO	X

▶ Limites mini des manœuvres

	Tradi Bois
Zuni R	590 Dos de coulisses
Radio IO et RTS	560 Dos de coulisses
Filaire SIMU	560 Dos de coulisses
Filaire SOMFY	560 Dos de coulisses
TO	400 Dos de coulisses

▶ Commandes individuelles et générales

Voir page 48-49

▶ Nuancier

Voir page 58-59